



**Clear-Flex II® Strip Door Installation
Instructions (Food Service Model)
Using the Maximus System™ Hardware**

Diagram 1
Side View

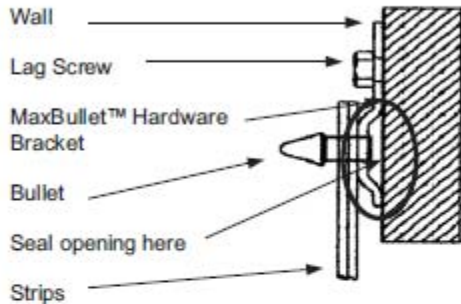

Diagram 2
Front View w/ Strip Spacing

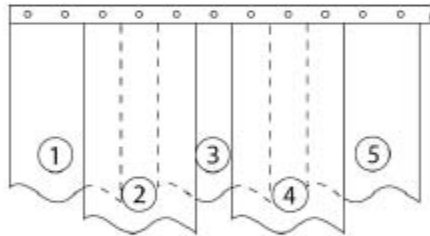

Diagram 3



TOOLS NEEDED

- Pen or Pencil to Mark Drill Holes
- Drill
- 5/16" Diameter Fasteners
- Step Stool or Ladder
- Utility Knife to Cut Strips



IMPORTANT

Prior to installation, unroll all door strips and place them on a clean, flat surface in a warm atmosphere for a minimum of twenty-four (24) hours. This will allow the strips to return to their original form.

1. Mount the MaxBullet™ hardware bracket using lag screws provided on the inside wall of walk-in, centered appropriately above conventional door opening.
2. Seal opening at ends of MaxBullet™ hardware bracket with NSF-approved silicone sealant (Diagram 1).
3. Press the door strips onto the "bullets" of the hardware bracket making certain that the concave sides are facing each other (Diagram 3). Attach strip numbers 1 and 3 (see Diagram 2) with concave side toward you, leaving desired spacing between strips as indicated by the diagram on reverse side of this sheet. Then attach strip number 2 with concave side away from you. Proceed with strip number 5 toward you, again leaving the appropriate spacing as per diagram on reverse side of this sheet. Proceed until all strips are in place.
4. Once all of the door strips have been attached, the strips can be trimmed to leave 1/4" of clearance from the floor surface. Your PVC door strips may be trimmed by using a common utility knife to score and then be torn by hand. **The door strips need to hang for 24 to 48 hours before final trim to allow for proper alignment.**

* NSF certification applies when hardware is installed with approved low-temp PVC strip material.

STRIP PLACEMENT GUIDE

PARTIAL OVERLAP

FULL OVERLAP

6" WIDE MATERIAL

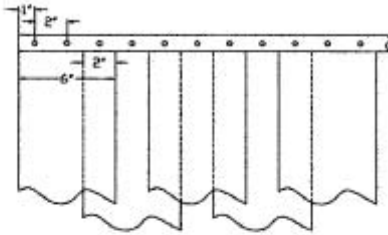

PARTIAL OVERLAP 66%

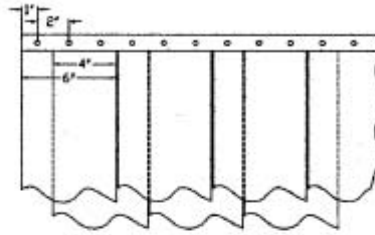

FULL OVERLAP 100%

8" WIDE MATERIAL

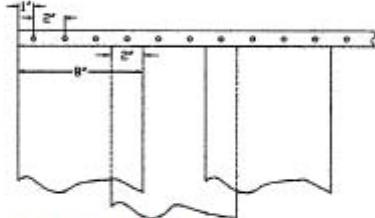

PARTIAL OVERLAP 50%

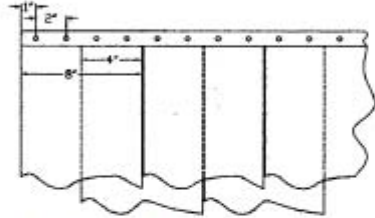

FULL OVERLAP 100%

12" WIDE MATERIAL

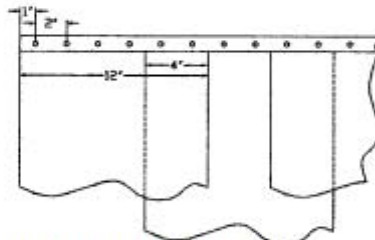

PARTIAL OVERLAP 66% (4")
PARTIAL OVERLAP 33% (2")

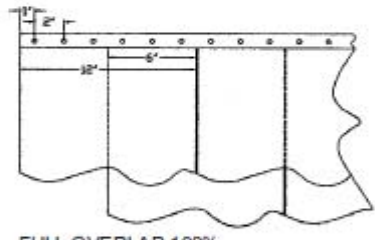

FULL OVERLAP 100%

16" WIDE MATERIAL

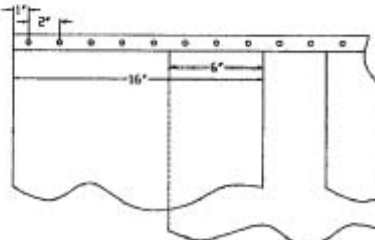

PARTIAL OVERLAP 75% (6")
PARTIAL OVERLAP 50% (4")
PARTIAL OVERLAP 25% (2")

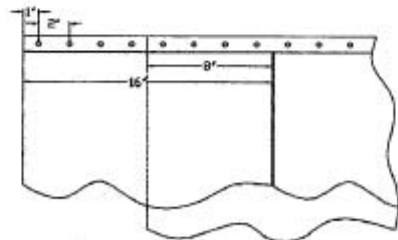

FULL OVERLAP 100%

Specially formulated Vinyl Strip Cleaner available exclusively through your local Aleco distributor.